

#FSLM2520-150J=P2

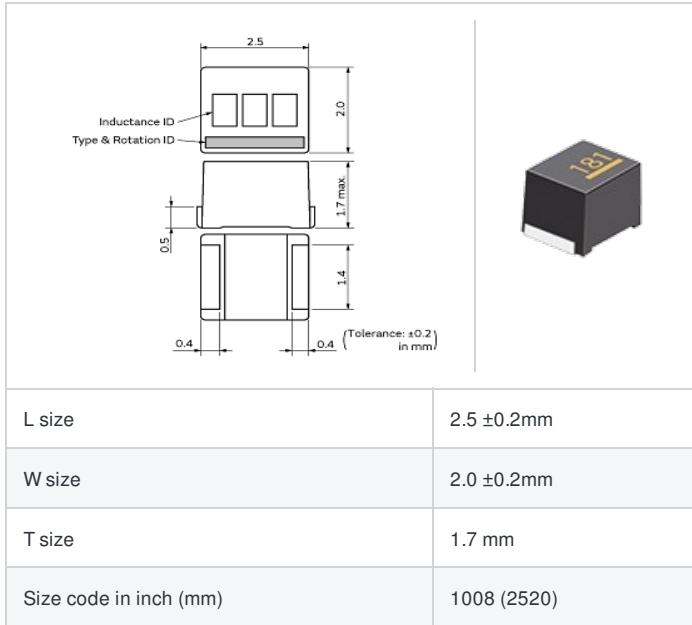

< List of part numbers with package codes >
#FSLM2520-150J=P2

Shape



Notes

Rated current is specified when the decrease of the initial inductance value at 10%. (The ambient reference temperature is 20°C.)
OR rated current is specified when temperature of inductor the is raised 20°C by DC current. (The ambient reference temperature is 20°C.)
Whichever is smaller.

References

Packaging code	Specifications	Minimum quantity
=P2	φ180mm Embossed taping	2000

Mass (Typ.)	
1 piece	0.02g

Specifications

Inductance	15μH ±5%
Inductance test frequency	2.52MHz
Rated current	140mA
Max. of DC resistance	2.80Ω
Q (min.)	25
Q test frequency	2.52MHz
Self resonance frequency (min.)	23MHz
Operating temperature range (Self-temperature rise is included)	-40~85°C
Class of magnetic shield	No Shield
Series	LLM2520

Attention

- 1.This datasheet is downloaded from the website of Murata Manufacturing Co., Ltd. Therefore, it's specifications are subject to change or our products in it may be discontinued without advance notice. Please check with our sales representatives or product engineers before ordering.
- 2.This datasheet has only typical specifications because there is no space for detailed specifications. Therefore, please review our product specifications or consult the approval sheet for product specifications before ordering.

Chart of characteristic data (The charts below may show another part number which shares its characteristics.)

▪ Q-Frequency characteristics (Typ.)

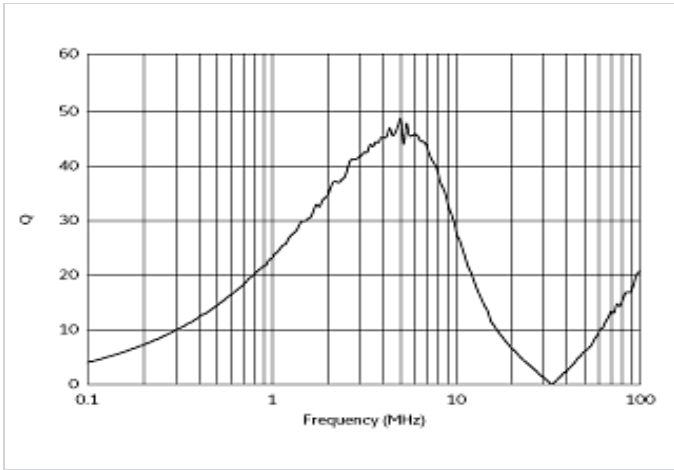

⚠ Attention

- 1.This datasheet is downloaded from the website of Murata Manufacturing Co., Ltd. Therefore, it's specifications are subject to change or our products in it may be discontinued without advance notice. Please check with our sales representatives or product engineers before ordering.
- 2.This datasheet has only typical specifications because there is no space for detailed specifications.
Therefore, please review our product specifications or consult the approval sheet for product specifications before ordering.